

Switch Boxes and Accessories

Steel City® Super Deep 4" Square Wall Boxes

- Increased capacity accommodates large devices in commercial and industrial applications, such as fire alarm systems
- Red-painted version available for quick and easy identification of life safety electrical systems
- Available with or without integrally mounted support bracket

NEW!

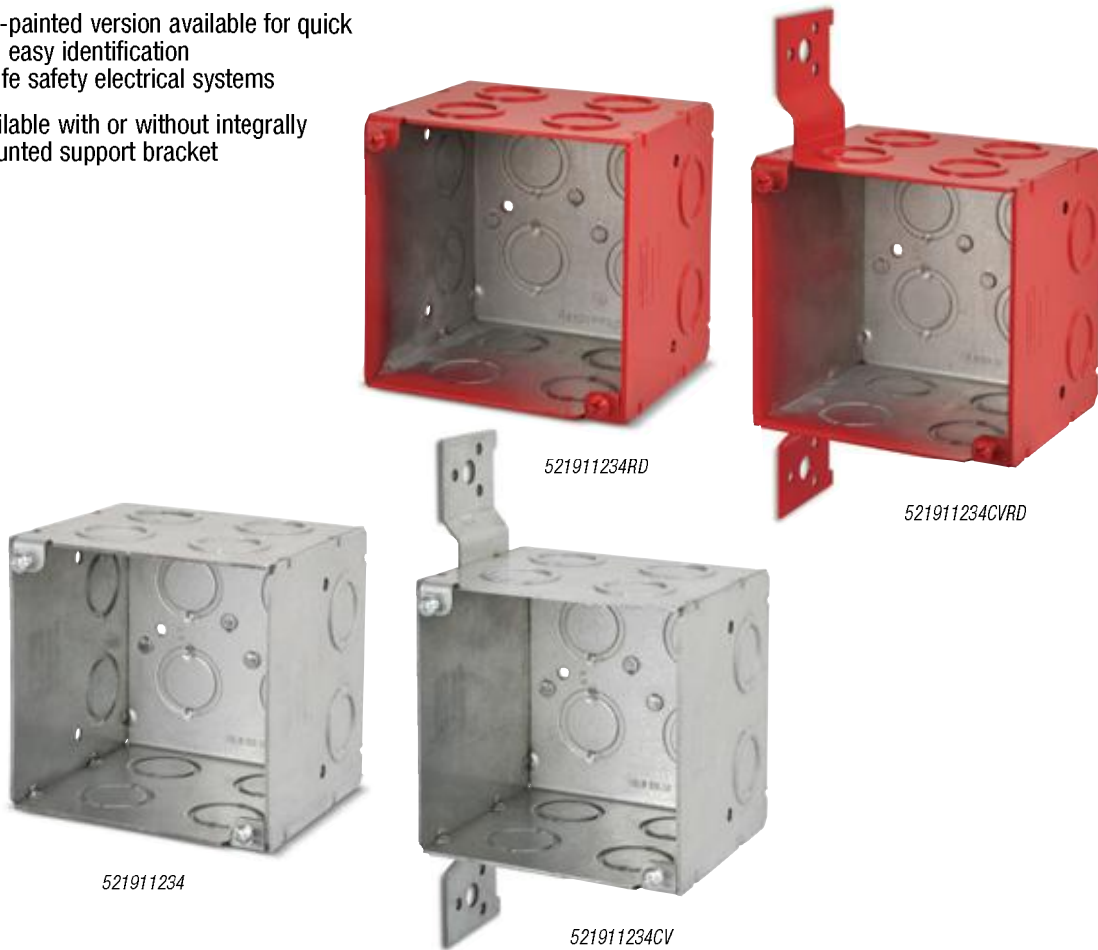

Boxes & Covers — Steel City® Metallic Boxes

CAT. NO.	DESCRIPTION	EARS	BRACKETS	EACH SIDE KO	EACH END KO	BOTTOM KO	CU. IN. CAPACITY	STD. CTN.
521911234RD	3½"-Deep, 4"-Square Red Box	—	—	(4) ½" & ¾" Combo	(2) ½" & ¾" Combo	(4) ½" & ¾" Combo	46	24
521911234CVRD	3½"-Deep, 4"-Square Red Box with Side Mounting Bracket	—	CV	(4) ½" & ¾" Combo	(2) ½" & ¾" Combo	(4) ½" & ¾" Combo	46	10
521911234	3½"-Deep, 4"-Square Box	—	—	(4) ½" & ¾" Combo	(2) ½" & ¾" Combo	(4) ½" & ¾" Combo	46	24
521911234CV	3½"-Deep, 4"-Square Box with Side Mounting Bracket	—	CV	(4) ½" & ¾" Combo	(2) ½" & ¾" Combo	(4) ½" & ¾" Combo	46	10

Switch Boxes and Accessories

Easy Depth Adjustment After Wall Covering Installation.

Adjust-A-Box®

The Adjust-A-Box System adapts to a variety of wall coverings. Its unique design enables the installer to adjust the box to various depths with the turn of a screw.

Features:

- Unique design allows for adjustment of depth after the wall covering has been installed
- Adjusts to any wall covering
- Mounts square and secure every time
- Removes easily to enable inner-wall access
- Accommodates high- and low-voltage applications
- Pre-installed ground screw
- Accommodates non-metallic cable, flexible metal cable and EMT



MB120ADJ

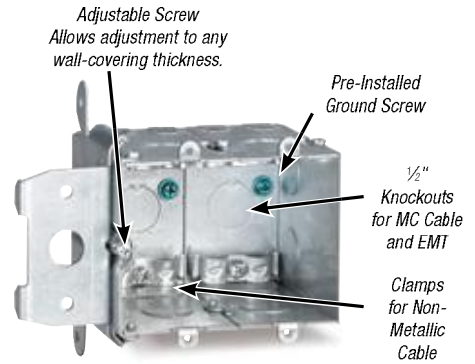

MB238ADJ

Installation:

Screw bracket to stud



Single-Gang



Two-Gang

Adjust box in or out to any wall thickness



Single-Gang



Two-Gang



CAT. NO.	VOLUME (CU. IN.)	DESCRIPTION	KNOCKOUTS	SIZE (IN.)	STD. CTN.	STD. WT. (LBS.)
MB120ADJ	20	One-Gang Adjustable Wall Box	½" (5)	2.20W x 3.28H x 3.52D	18	19.25
MB238ADJ	38	Two-Gang Adjustable Wall Box	½" (8)	4.01W x 3.28H x 3.52D	12	17.60

3¾" x 2" Switch Boxes

CAT. NO.	DEPTH (IN.)	CU. IN. CAPACITY	CLAMPS	EARS	BRKTS.	KNOCKOUTS	STD. CTN.
Non-Gangable							
SSV	1	6.5	—	—	Flat	2 pry-outs one end	25
SSQV	1	6.5	Yes	—	Flat	2 pry-outs one end with non-metallic cable clamps	25

Not UL Listed.



SSV

Switch Boxes and Accessories

3" x 2" Switch Boxes



SWB-25
Ears flush
for old work

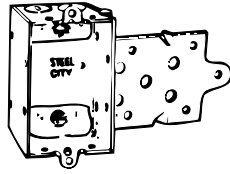

811-SW-25
S bracket recessed 5/8"



LXMWOW-25
Ears flush
for old work



LCOW-25
Ears flush
old work



LCOWC
Adapts to any wall
thickness up to 3/4"



LCLE-25



LCV-25
CV bracket
recessed 3/4"

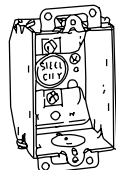

LCNOW-25
Ears flush
for old work

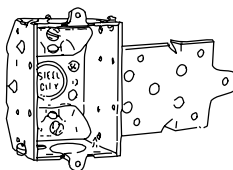

802-S
S bracket recessed 5/8"

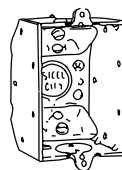

A12-25

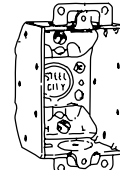

A12E-25
Ears flush

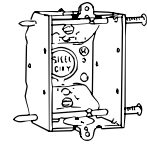

A16-25
With nails



LXWOW-25
Ears flush
for old work



LXWOWP



LXWLE-25



LXWOWC-25
Adapts to any wall
thickness up to 3/4"



LXWSV
SV bracket
recessed 1/8"



LXWV-25
CV bracket
recessed 5/8"

With Non-Metallic Sheathed Cable Clamps

CAT. NO.	DEPTH (IN.)	GANGABLE	CU. IN. CAPACITY	CLAMPS	EARS	BRKTS.	KNOCKOUTS (IN.)					STD. CTN.
							EA. END CONDUIT	EA. END CABLE	CABLE	BOTTOM CABLE	BOTTOM CONDUIT	
SWB-25	1½	—	7.5	C-5	Yes	—	—	2	—	2	—	25
811 SW-25	1½	—	7.5	C-5	—	S	—	2	—	2	—	50
LXMWOW-25	2	Yes	10.5	C-5	Yes	—	—	2	—	—	1-½	25
LCOW-25*	2¼	Yes	10.5	C-1	Yes	—	1-½	—	2	—	1-½	25
LCOWC*	2¼	Yes	10.5	C-1	Yes	—	1-½	—	2	—	1-½	25
LCLE-25*	2¼	Yes	10.5	C-1	—	—	1-½	—	2	—	1-½	25
LCV-25*	2¼	Yes	10.5	C-1	—	CV	1-½	—	2	—	1-½	25
LCNOW-25*	2¼	Yes	10.5	C-1	Yes	—	1-½	—	2	—	1-½	25
802 S*	2¼	Yes	10.5	C-1	—	S	1-½	—	2	—	1-½	25
A12-25	2¼	—	10.5	C-1	—	—	1-½	—	2	—	1-½	25
A12E-25	2¼	—	10.5	C-1	Yes	—	1-½	—	2	—	1-½	25
A16-25	2¼	—	10.5	C-1	—	—	1-½	—	2	—	1-½	25
LXWOW-25	2½	Yes	12.5	C-5	Yes	—	1-½	—	2	—	1-½	25
LXWOWP	2½	Yes	12.5	C-5	Yes	—	1-½	—	2	—	1-½	25
LXWLE-25	2½	Yes	12.5	C-5	—	—	1-½	1-½	2	—	1-½	25
LXWOWC-25	2½	Yes	12.5	C-5	Yes	—	1-½	—	2	—	1-½	25
LXWSV	2½	Yes	12.5	C-5	—	SV	1-½	1-½	2	—	1-½	25
LXWV-25	2½	Yes	12.5	C-5	—	CV	1-½	1-½	2	—	1-½	25

* Beveled corners.

Switch Boxes and Accessories

3" x 2" Switch Boxes (continued)

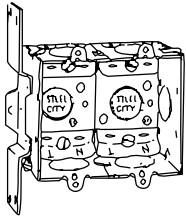

LXWV 2G
2-gang with CV
bracket recessed 7/8"



806 SW
S bracket recessed 5/8"

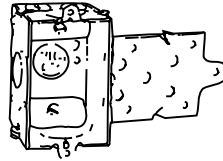

806 SW 1/4
S bracket recessed 1/4"

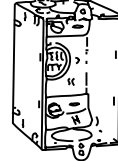

A254-25

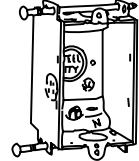

A257-25
With nails slanted
for easy drive-in

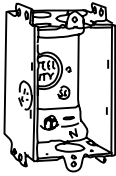

A-258
Without nails



CWN-25
Ears flush



CWNLE

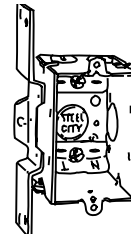

CWNV-25
CV bracket
recessed 7/8"

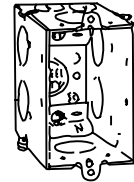

CXWLE



CXWOW
Ears flush
for old work

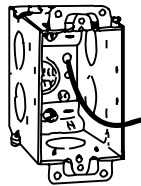

CXWOWP

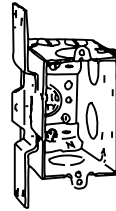

CXWV
CV bracket
recessed 1/8"



CXWVP

With Non-Metallic Sheathed Cable Clamps (continued)

CAT. NO.	DEPTH (IN.)	GANGABLE	CU. IN. CAPACITY	CLAMPS	EARS	BRKTS.	KNOCKOUTS (IN.)					STD. CTN.
							EA. END CONDUIT	EA. END CABLE	CABLE	BOTTOM CABLE	BOTTOM CONDUIT	
LXWV 2G	2½	Yes	12.5	C-5	—	CV	1-½	2-½	4	—	2-½	25
806 SW	2½	Yes	12.5	C-5	—	S	1-½	1-½	2	—	1-½	25
806 SW 1/4	2½	Yes	12.5	C-5	—	S	1-½	1-1½	2	—	1-½	25
A254-25	2½	—	12.5	C-5	—	—	—	1-½	2	—	1-½	25
A257-25	2½	—	12.5	C-5	—	—	—	1-½	2	—	1-½	25
A-258	2½	—	12.5	C-5	—	—	—	1-½	2	—	1-½	25
CWN-25	2¾	Yes	14.0	C-5	Yes	—	1-½	—	2	—	1-½	25
CWNLE	2¾	Yes	14.0	C-5	—	—	1-½	—	2	—	1-½	25
CWNV-25	2¾	Yes	14.0	C-5	—	CV	1-½	—	2	—	1-½	25
CXWLE	3½	Yes	18.0	C-5	—	—	2-½	1-½	2	—	1-½	25
CXWOW	3½	Yes	18.0	C-5	Yes	—	2-½	1-½	2	—	1-½	25
CXWOWP	3½	Yes	18.0	C-5	Yes	—	2-½	1-½	2	—	1-½	25
CXWV	3½	Yes	18.0	C-5	—	CV	2-1½	1-½	2	—	1-½	25
CXWVP	3½	Yes	18.0	C-5	—	CV	2-½	1-½	2	—	1-1½	25

Switch Boxes and Accessories

3" x 2" Switch Boxes (continued)



CDOW
Ears flush



CDOWTG-25
Ears flush



CDLE-25

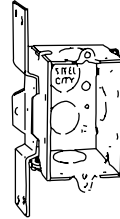

CDV-25
CV bracket
recessed 7/8"

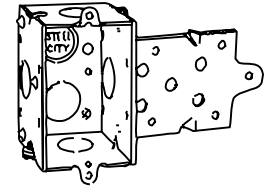

804 S
S bracket recessed 5/8"



CW 1/2
Ears flush



CW3/4-25
Ears flush



CWLE1/2-25



CWLE 3/4

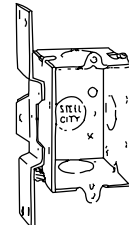

CWV 1/2
CV bracket
recessed 7/8"



CY 1/2
Ears flush

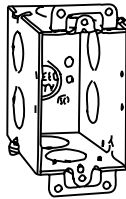

CY 3/4
Ears flush

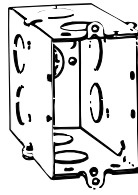

CYLE 1/2

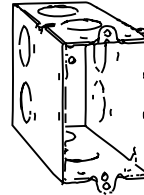

CYLE 3/4

With Conduit KOs

CAT. NO.	DEPTH (IN.)	GANGABLE	CU. IN. CAPACITY	EARS	BRKTS.	KNOCKOUTS (IN.)			STD. CTN.
						EA. END CONDUIT	EA. END CABLE	BOTTOM CONDUIT	
CDOW	2½	Yes	12.5	Yes	—	1½	1½	2½	50
CDOWTG-25	2½	Yes	12.5	Yes	—	1½	1½	2½	25
CDLE-25	2½	Yes	12.5	—	—	1½	1½	2½	25
CDV-25	2½	Yes	12.5	—	CV	1½	1½	2½	25
804 S	2½	Yes	12.5	—	S	1½	1½	2½	25
CW 1/2	2¾	Yes	14.0	Yes	—	1-½	1-½	1-½	50
CW3/4-25	2¾	Yes	14.0	Yes	—	1-¾	1-¾	1-¾	25
CWLE1/2-25	2¾	Yes	14.0	—	—	1-½	1-½	1-½	25
CWLE 3/4	2¾	Yes	14.0	—	—	1-¾	1-¾	1-¾	25
CWV 1/2	2¾	Yes	14.0	—	CV	1-½	1-½	1-½	25
CY 1/2	3½	Yes	18.0	Yes	—	2-½	2-½	1-½	25
CY 3/4	3½	Yes	18.0	Yes	—	2-¾	2-¾	1-½	25
CYLE 1/2	3½	Yes	18.0	—	—	2-½	2-½	1-½	25
CYLE 3/4	3½	Yes	18.0	—	—	2-¾	2-¾	1-½	25

Switch Boxes and Accessories

3" x 2" Switch Boxes (continued)



LXMOV-25
Ears flush
for old work



LXOW-25
Ears flush
for old work



LXOWC-25
Adapts to 3/4"
wall thickness



LXLE



LXV-25
CV bracket
recessed 1/8"

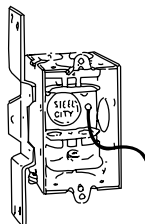

LXVP

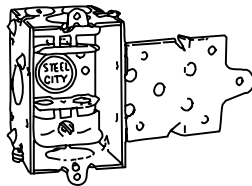

806 S
S bracket recessed 3/8"

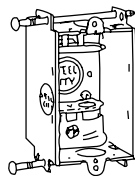

A-256
With nails slanted
for easy drive-in



CWX-25
Ears flush

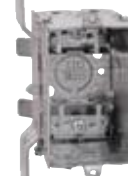

CWXV-25
CV bracket
recessed 1/2"



CX
Ears flush

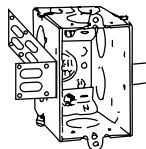

CXLE-SSX
For metal stud

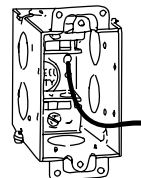

CXP



CXV
CV bracket
recessed 1/8"

With Armored Cable/Metal Clad Clamps

CAT. NO.	DEPTH (IN.)	GANGABLE	CU. IN. CAPACITY	CLAMPS	EARS	BRKTS.	KNOCKOUTS (IN.)			STD. CTN.	
							EA. END CONDUIT	EA. END CABLE	CABLE		
LXMOV-25	2	Yes	10.5	C-3	Yes	—	—	2	—	1-1/2	25
LXOW-25	2 1/2	Yes	12.5	C-3	Yes	—	1-1/2	—	2	1-1/2	25
LXOWC-25	2 1/2	Yes	12.5	C-3	Yes	—	1-1/2	—	2	1-1/2	25
LXLE	2 1/2	Yes	12.5	C-3	—	—	1-1/2	1-1/2	2	1-1/2	25
LXV-25	2 1/2	Yes	12.5	C-3	—	CV	1-1/2	1-1/2	2	1-1/2	25
LXVP	2 1/2	Yes	12.5	C-3	—	CV	1-1/2	1-1/2	2	1-1/2	25
806 S	2 1/2	Yes	12.5	C-3	—	S	1-1/2	1-1/2	2	1-1/2	25
A-256	2 1/2	—	12.5	C-3	—	—	—	1-1/2	2	1-1/2	25
CWX-25	2 3/4	Yes	14.0	C-3	Yes	—	1-1/2	—	2	1-1/2	25
CWXV-25	2 3/4	Yes	14.0	C-3	—	CV	1-1/2	—	2	1-1/2	25
CX	3 1/2	Yes	18.0	C-3	Yes	—	2-1/2	1-1/2	2	1-1/2	25
CXLE-SSX	3 1/2	Yes	18.0	C-3	No	SSX	2-1/2	1-1/2	2	1-1/2	25
CXP	3 1/2	Yes	18.0	C-3	Yes	—	2-1/2	1-1/2	2	1-1/2	25
CXV	3 1/2	Yes	18.0	C-3	—	CV	2-1/2	1-1/2	2	1-1/2	25

Switch Boxes and Accessories

Gangable Switch Boxes — 2" Deep



51

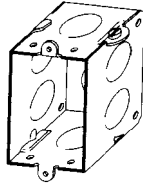

51-NE

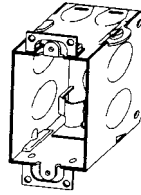

51-LC

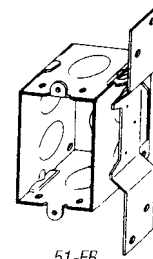

51-FB

CAT. NO.	CU. IN. CAPACITY	DESCRIPTION	STD. CTN.
51	10.0	2" deep x 3" long x 2" wide Two ½" KOs in each of two sides, one ½" KO in each end and two ½" KOs in bottom. Two nail holes in sides. Furnished with plaster ears*	50
51-NE	10.0	2" deep x 3" long x 2" wide Two ½" KOs in each of two sides, one ½" KO in each end and two ½" KOs in bottom. Two nail holes in sides*	50
51-LC	10.0	For Non-Metallic Cable, 2" deep x 3" long x 2" wide Two ½" KOs in each of two sides, two Loom KOs in each end and one ½" KO in bottom. Furnished with plaster ears. One Loom clamp for use on non-metallic sheathed cable with 10/32 deep-slotted screw assembled. Two nail holes in sides*	50
51-FB	10.0	2" deep x 3" long x 2" wide Two ½" KOs in one side, flat bracket on other side, one ½" KO in each end and two ½" KOs in bottom. Bracket offset ⅞" from face*	50

*Uses Steel City® 100 series covers.

Gangable Switch Boxes — 2½" Deep

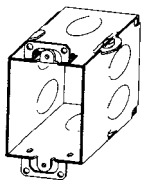

52

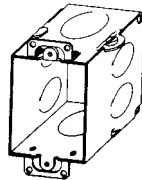

52-3/4-BW

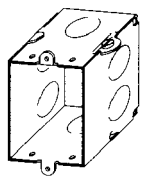

52-NE

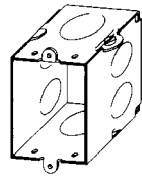

52-NE-3/4

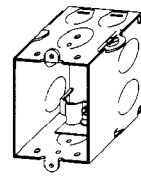

52-LCNE

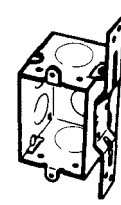

52-FB-3/4

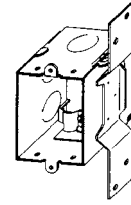

52-FBC

CAT. NO.	CU. IN. CAPACITY	DESCRIPTION	STD. CTN.
52	12.5	2½" deep x 3" long x 2" wide Two ½" KOs in each of two sides, one ½" KO in each end and two ½" KOs in bottom. Furnished with plaster ears. Four nail holes in sides*	50
52-3/4-BW	12.5	2½" deep x 3" long x 2" wide Two ½" KOs in each of two sides, one ¾" KO in each end and two ½" KOs in bottom. Furnished with plaster ears. Four nail holes in sides*	50
52-NE	12.5	2½" deep x 3" long x 2" wide Two ½" KOs in each of two sides, one ½" KO in each end and two ½" KOs in bottom. Four nail holes in sides*	50
52-NE-3/4	12.5	2½" deep x 3" long x 2" wide Two ½" KOs in each of two sides, one ¾" KO in each end and two ½" KOs in bottom. Four nail holes in sides*	50
52-LCNE	12.5	For Non-Metallic Cable, 2½" deep x 3" long x 2" wide Two ½" KOs in each side, two Loom KOs and one ½" KO in each end. One ½" KO in bottom. One Loom clamp for use on non-metallic sheathed cable with 10/32 deep-slotted screw assembled. Four nail holes in sides*	50
52-FB-3/4	12.5	2½" deep x 3" long x 2" wide Two ½" KOs in one side, flat bracket on other side, one KO in each end and two ¾" KOs in bottom. Flat bracket offset ⅞" from face*	50
52-FBC	12.5	For Non-Metallic Cable, 2½" deep x 3" long x 2" wide Two ½" KOs in one side, flat bracket on other side, two Loom KOs and one ½" KO in each end and one ½" KO in bottom. One Loom clamp for use on non-metallic sheathed cable with 10/32 deep-slotted screw assembled. Flat bracket offset ⅞" from face*	50

*Uses Steel City® 100 series covers.

Switch Boxes and Accessories

Gangable Switch Boxes — 2¾" Deep

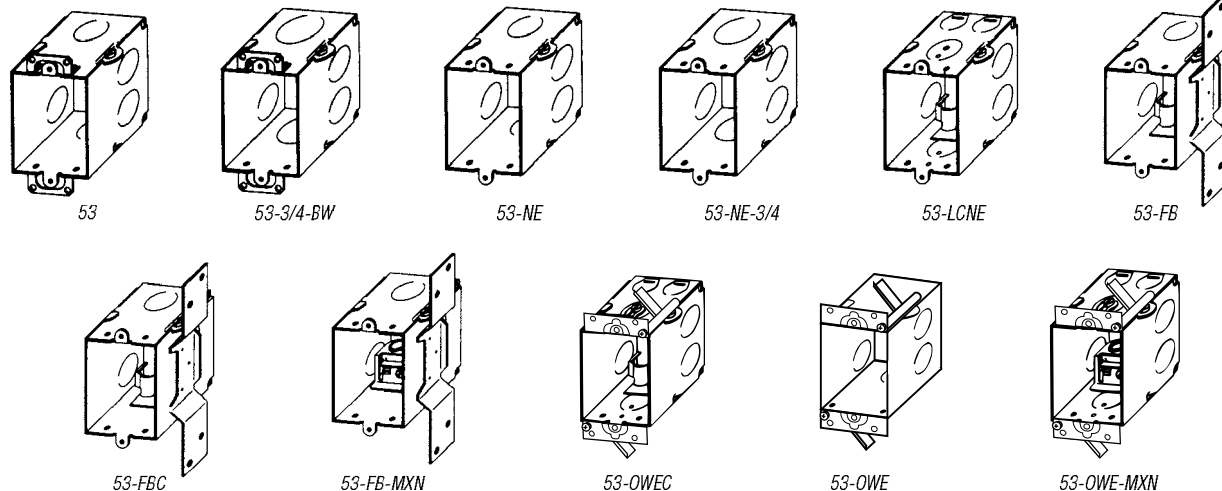

CAT. NO.	CU. IN. CAPACITY	DESCRIPTION	STD. CTN.
53	14.0	2¾" deep x 3" long x 2" wide Two ½" KOs in each side, one ½" KO in each end and two ½" KOs in bottom. Furnished with plaster ears. Four nail holes in sides*	50
53-3/4-BW	14.0	2¾" deep x 3" long x 2" wide Two ½" KOs in each side, one ¾" KO in each end and two ½" KOs in bottom. Furnished with plaster ears. Four nail holes in sides*	50
53-NE	14.0	2¾" deep x 3" long x 2" wide Two ½" KOs in each side, one ½" KO in each end and two ½" KOs in bottom. Four nail holes in sides*	50
53-NE-3/4	14.0	2¾" deep x 3" long x 2" wide Two ½" KOs in each side, one ¾" KO in each end and two ½" KOs in bottom. Four nail holes in sides*	50
53-LCNE	14.0	For Non-Metallic Cable, 2¾" deep x 3" long x 2" wide Two ½" KOs in each side, two Loom KOs and one ½" KO in each end and one ½" KO in bottom. One Loom clamp for use on non-metallic sheathed cable with 10/32 deep-slotted screw assembled. Four nail holes in sides*	50
53-FB	14.0	2¾" deep x 3" long x 2" wide Two ½" KOs in one side, flat bracket on other side, one ½" KO in each end and two ½" KOs in bottom. Flat bracket offset ⅞" from face*	50
53-FBC	14.0	For Non-Metallic Cable, 2¾" deep x 3" long x 2" wide Two ½" KOs in one side, flat bracket on other side, two Loom KOs and one ½" KO in each end and one ½" KO in bottom. Flat offset ⅞" from face. One Loom clamp for use on non-metallic sheathed cable with 10/32 deep-slotted screw assembled*	50
53-FB-MXN	14.0	For Metal Clad Cable, 2¾" deep x 3" long x 2" wide Two ½" KOs in one side, flat bracket on other side, two Loom KOs and one ½" KO in each end, and one ½" KO in bottom. One MXN clamp for MC, AC/BX, and non-metallic sheathed cable (NM) included with 10/32 deep-slotted screw. Clamp is UL Listed for use with cable sizes 14/2 through 10/3 with ground*	50
53-OWEC	14.0	For Non-Metallic Cable, 2¾" deep x 3" long x 2" wide Two ½" KOs in each side, two Loom KOs and one ½" KO in each end and one ½" KO in bottom. Furnished with plaster ears. One Loom clamp for use on non-metallic sheathed cable with 10/32 deep-slotted screw assembled. With old-work swing brackets*	50
53-OWE	14.0	2¾" deep x 3" long x 2" wide Two ½" KOs in each side, one ½" KO in each end and two ½" KOs in bottom. Furnished with plaster ears. With old-work swing brackets*	50
53-OWE-MXN	14.0	For Metal-Clad Cable, 2¾" deep x 3" long x 2" wide Two ½" KOs in each side. Two Loom KOs and one ½" KO in each end and one ½" KO in bottom. One MXN clamp for MC, AC/BX and non-metallic sheathed cable (NM) included with 10/32 deep-slotted screw. Clamp is UL Listed for use with cable sizes 14/2 through 10/3 with ground. Furnished with plaster ears. With old-work swing brackets*	50

*Uses Steel City® 100 series covers.

Switch Boxes and Accessories

Gangable Switch Boxes — 3½" Deep

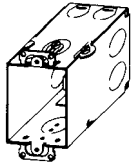

54-LC

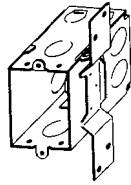

54-FBC

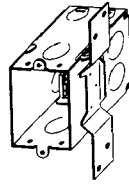

54-FB-MXN

CAT. NO.	CU. IN. CAPACITY	DESCRIPTION	STD. CTN.
54-LC	18.0	For Non-Metallic Cable 3½" deep x 3" long x 2" wide Two ½" KOs in each side, two Loom KOs and one ½" KO in each end and one ½" KO in bottom. Two Loom clamps for use on non-metallic sheathed cable with 10/32 deep-slotted screws assembled. Furnished with plaster ears. Four nail holes in sides*	50
54-FBC	18.0	For Non-Metallic Cable 3½" deep x 3" long x 2" wide Two ½" KOs in one side, flat bracket and two ½" KOs in other side, two Loom KOs and one ½" KO in each end and one ½" KO in bottom. Two Loom clamps for use on non-metallic sheathed cable with 10/32 deep-slotted screws assembled. Flat bracket offset ⅜" from face*	50
54-FB-MXN	18.0	For Metal Cable, 3½" deep x 3" long x 2" wide Two ½" KOs in one side, flat bracket and two ½" KOs in other side, two Loom KOs and one ½" KO in each end and one ½" KO in bottom. Two MXN clamps for MC, AC/BX, and non-metallic sheathed cable (NM) included with 10/32 deep-slotted screws. Clamps are UL Listed for use with cable sizes 14/2 through 10/3 with ground. Flat bracket offset ⅜" from face*	50

*Uses Steel City® 100 series covers.

Welded Non-Gangable Switch Boxes — 2½" Deep

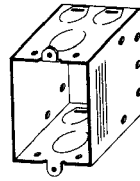

72

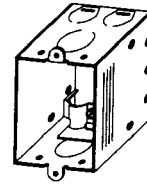

72-C

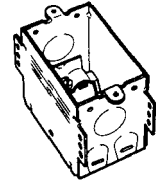

72-OC

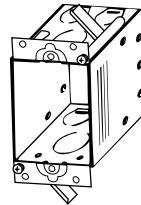

72-OWE

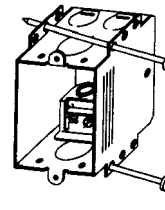

72-ONS-MXN

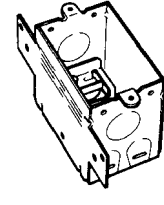

72-FB-MXN

CAT. NO.	CU. IN. CAPACITY	DESCRIPTION	STD. CTN.
72	12.5	2½" deep x 3" long x 2" wide Two Loom KOs and one ½" KO in each end and one ½" KO in bottom. Four nail holes included*	50
72-C	12.5	For Non-Metallic Cable 2½" deep x 3" long x 2" wide Two Loom KOs and one ½" KO in each end and one ½" KO in bottom. Four nail holes included. One Loom clamp for use on non-metallic sheathed cable with 10/32 deep-slotted screw assembled*	50
72-OC	12.5	For Non-Metallic Cable 2½" deep x 3" long x 2" wide Two Loom KOs and one ½" KO in each end and one ½" KO in bottom. One Loom clamp for use on non-metallic sheathed cable with 10/32 deep-slotted screw assembled. Four nail holes included. Provisions for external nails included*	50
72-OWE	12.5	2½" deep x 3" long x 2" wide Two Loom KOs and one ½" KO in each end and one ½" KO in bottom. With old-work swing brackets*	50
72-ONS-MXN	12.5	For Metal-Clad Cable 2½" deep x 3" long x 2" wide Two Loom KOs and one ½" KO in each end and one ½" KO in bottom. One MXN clamp for MC, AC/BX and nonmetallic sheathed cable (NM) included with 10/32 deep-slotted screw. Clamp is UL Listed for use with cable sizes 14/2 through 10/3 with ground. Four nail holes included. Two 16-penny nails swaged at an angle in box*	50
72-FB-MXN	12.5	For Metal-Clad Cable 2½" deep x 3" long x 2" wide Two Loom KOs and one ½" KO in each end, one ½" KO in bottom and flat bracket on one side offset ⅜" from face. Two MXN clamps for MC, AC/BX and non-metallic sheathed cable (NM) included with 10/32 deep-slotted screws. Clamps are UL Listed for use with cable sizes 14/2 through 10/3 with ground. Four nail holes included*	50

*Uses Steel City® 100 series covers.

Switch Boxes and Accessories

Welded Non-Gangable Switch Boxes — 2¹³/₁₆" Deep

CAT. NO.	CU. IN. CAPACITY	DESCRIPTION	STD. CTN.
73-ONCS	15.8	For Non-metallic Cable, 2¹³/₁₆" deep x 3" long x 2⁹/₁₆" wide Two Loom KOs and one 1/2" KO in each end and one 1/2" KO in bottom. One Loom clamp for use on non-metallic sheathed cable with 10/32 deep-slotted screw assembled. Two 16-penny nails swaged at an angle in box*	50
73-FBC	15.8	For Non-metallic Cable, 2¹³/₁₆" deep x 3" long x 2⁹/₁₆" wide Two Loom KOs and one 1/2" KO in each end, one 1/2" KO in bottom and flat bracket on one side offset 3/16" from face. One Loom clamp for use on non-metallic sheathed cable with 10/32 deep-slotted screw assembled. Four nail holes included*	50
73-FB-MXN	15.8	For Metal-Clad Cable, 2¹³/₁₆" deep x 3" long x 2⁹/₁₆" wide Two Loom KOs and one 1/2" KO in each end, one 1/2" KO in bottom and flat bracket on one side offset 3/16" from face. One MXN clamp for MC, AC/BX and non-metallic sheathed cable (NM) included with 10/32 deep-slotted screw. Clamp is UL Listed for use with cable sizes 14/2 through 10/3 with ground. Four nail holes included*	50

*Uses Steel City® 100 series covers.

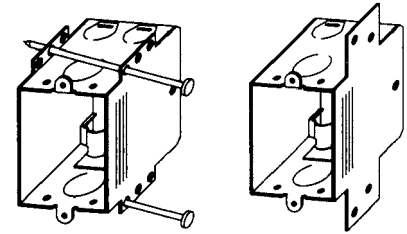

73-ONCS

73-FBC

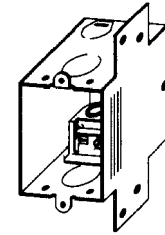

73-FB-MXN

Welded Non-Gangable Switch Boxes — 3" Deep

CAT. NO.	CU. IN. CAPACITY	DESCRIPTION	STD. CTN.
74-CE	18	For Non-metallic Cable, 3/4" deep x 3" long x 2 1/4" wide Two Loom KOs and one 1/2" KO in each end and one 1/2" KO in bottom. One Loom clamp for use on non-metallic sheathed cable with 10/32 deep-slotted screw assembled. Furnished with ears. Four nail holes included*	50
74-ONCS	18	For Non-metallic Cable, 3/4" deep x 3" long x 2 1/4" wide Two Loom KOs and one 1/2" KO in each end and one 1/2" KO in bottom. One Loom clamp for use on non-metallic sheathed cable with 10/32 deep-slotted screw assembled. Two 16-penny nails swaged at an angle in box*	50
74-FBC	18	For Non-metallic Cable, 3/4" deep x 3" long x 2 1/4" wide Two Loom KOs and one 1/2" KO in each end, one 1/2" KO in bottom and flat bracket on one side offset 3/16" from face. One Loom clamp for use on non-metallic sheathed cable with 10/32 deep-slotted screw assembled. Four nail holes included*	50

*Uses Steel City® 100 series covers.

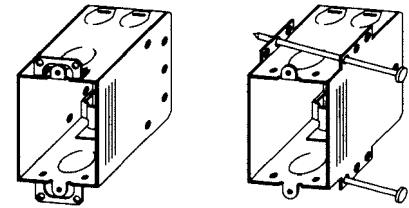

74-CE

74-ONCS

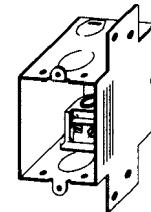

74-FBC

Welded Non-Gangable Switch Box — 3¹³/₃₂" Deep

CAT. NO.	CU. IN. CAPACITY	DESCRIPTION	STD. CTN.
75-ONCS	20.0	For Non-metallic Cable, 3¹³/₃₂" deep x 3" long x 2 1/4" wide Two Loom KOs and one 1/2" KO in each end and one 1/2" KO in bottom. Two Loom clamp for use on non-metallic sheathed cable with 10/32 deep-slotted screw assembled. Four nail holes included. Two 16-penny nails swaged at angle in box*.	50

*Uses Steel City® 100 series covers.

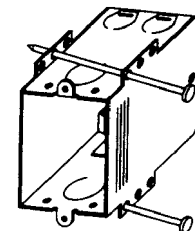

75-ONCS

Switch Boxes and Accessories

Welded Multi-Gangable Switch Boxes — 2½" Deep

CAT. NO.	CAPACITY	DESCRIPTION	STD. CTN.
271-FBC	25.0	A Two-Gang Box — For Non-Metallic Cable, 2½" deep x 3" long x 4" wide Two Loom KOs and two ½" KOs in each end, flat bracket on one side and one ½" KO in bottom. Two Loom clamps for use on non-metallic sheathed cable with 10/32 deep-slotted screws assembled. Flat bracket offset ⅜" from face*	25
271-FB-MXN	25.0	A Two-Gang Box — For Metal-Clad Cable, 2½" deep x 3" long x 4" wide Two Loom KOs and two ½" KOs in each end, flat bracket on one side and one ½" KO in bottom. Two MXN clamps for MC, AC/BX and non-metallic sheathed cable (NM) included with 10/32 deep-slotted screws. Clamps are UL Listed for use with cable sizes 14/2 through 10/3 with ground. Flat bracket offset ⅜" from face*	25

*Uses Steel City® SB-2 covers.

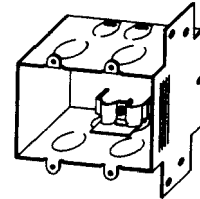

271-FBC

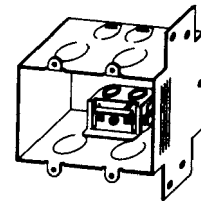

271-FB-MXN

Boxes & Covers — Steel City® Metallic Boxes

4" x 2½" Thru-Wall Box

CAT. NO.	CU. IN. CAPACITY	DESCRIPTION	BOX DEPTH (IN.)	STD. CTN.
With Conduit KOs for Plaster or Dry Wall				
CTDW	32.0	Drywall, partition type; one ½" and one ¾" KO both ends; one ½" KO on one side, V bracket other side	4⅞	25



CTDW

Switch Box Extension

CAT. NO.	DESCRIPTION	STD. CTN.
SBEX	Cubic content 3.5 inches; fits snugly inside of all single-gang switch boxes; maximum adjustable depth ⅞"; furnished with 1¼"-long screws for mounting	50

UL Listing not applicable — subject to approval by local inspector.



SBEX

Switch Boxes and Accessories

Old-Work Box Support

- Quickly attaches box through finished drywall
- For up to 1½" thick drywall
- New 820D shipped in one-piece break-apart design
- Easy to install

CAT. NO.	FIG. NO.	DESCRIPTION	STD. CTN.
820D	1	Old-work switch box steel-mounting holder	500 sets

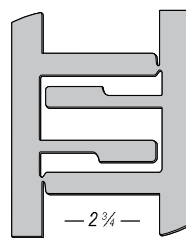
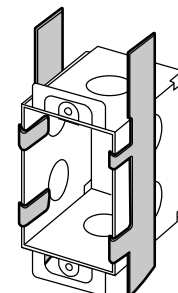

Fig. 1



Steel Low-Voltage Bracket

- Fixes to the switch box easily with the screws provided
- Works with any Steel City® switch box, regardless of depth
- Single-screw fixing as well as two-screw fixing
- Low-voltage cable support is provided by fitting location tabs
- UL Listed for low-voltage support



CAT. NO.	DESCRIPTION	BOX DEPTH (IN.)	STD. CTN.
LVB	Bracketed to T&B boxes; provides means of installing a low-voltage device alongside a regular switch or outlet	1 1/8	25

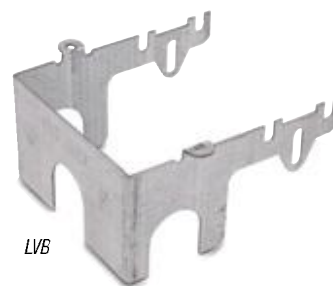

LVB

Old-Work Box Support Clips

- Adapts to any wall thickness up to ¾"

CAT. NO.	DESCRIPTION	STD. CTN.
OWC	Clips lock old-work steel switch boxes tightly to wall plaster, drywall, concrete block, brick or concrete. 2 required per box, (1 set)	250 sets
OW SWING EAR	Swing ears only (for field installations) with self-threading screws	50 (25 pair)

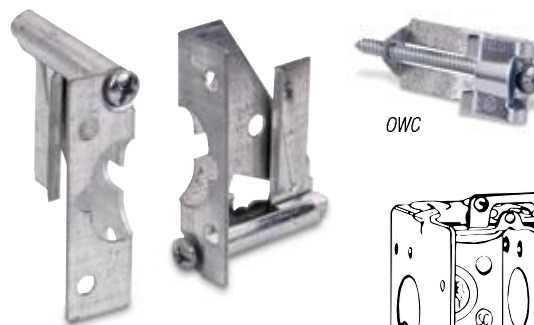

OW Swing Ear

OWC

